



WARNING: ALWAYS WEAR HEARING PROTECTION PER OSHA 1910.95

ONE YEAR LIMITED WARRANTY

The manufacturer warrants each new product against factory defects in material and workmanship for one year after the date of purchase. The owner will be responsible for returning to the Service Center any defective item(s) with the transportation costs prepaid. The manufacturer will, without charge, repair or replace at its option, products, or part(s), which its inspection determines to be defective. Repaired or replacement item(s) will be returned to the purchaser with transportation costs prepaid from the service point. A copy of the purchaser's receipt must be returned with the defective item(s) in order to qualify for the warranty coverage. Exclusions from this warranty include, but are not limited to, bulbs, strobe tubes, domes, and/or the finish. This warranty shall not apply to any light, which has been altered, such that in the manufacturer's judgment, the performance or reliability has been affected, or if any damage has resulted from abnormal use or service.

There are no warranties expressed or implied (including any warranty of merchantability or fitness), which extend this warranty period. **The loss of use of the product, loss of time, inconvenience, commercial loss or consequential damages, including costs of any labor, are not covered.** The manufacturer reserves the right to change the design of the product without assuming any obligation to modify any product previously manufactured.

This warranty gives you specific legal rights. You might also have additional rights that may vary from state to state. Some states do not allow limitations on how long an implied warranty lasts. Some states do not allow the exclusion or limitation of incidental or consequential damages. Therefore, the above limitation(s) or exclusion(s) may not apply to you.

If you have any questions concerning this or any other product, please contact our **Customer Service Department** at (585) 226-9025.

If a product must be returned for any reason, please contact our Customer Service Department to obtain a Returned Materials Authorization number (RMA #) before you ship the product back. Please write the RMA # clearly on the package near the mailing label.



NOTICE

Due to continuous product improvements, we must reserve the right to change any specifications and information, contained in this manual at any time without notice. The manufacturer makes no warranty of any kind with regard to this manual, including, but not limited to, the implied warranties of merchantability and fitness for a particular purpose. The manufacturer shall not be liable for errors contained herein or for incidental or consequential damages in connection with the furnishing, performance, or use of this manual.

INSTALLATION AND INSTRUCTION MANUAL

Model D-44 CYCLONE Speaker

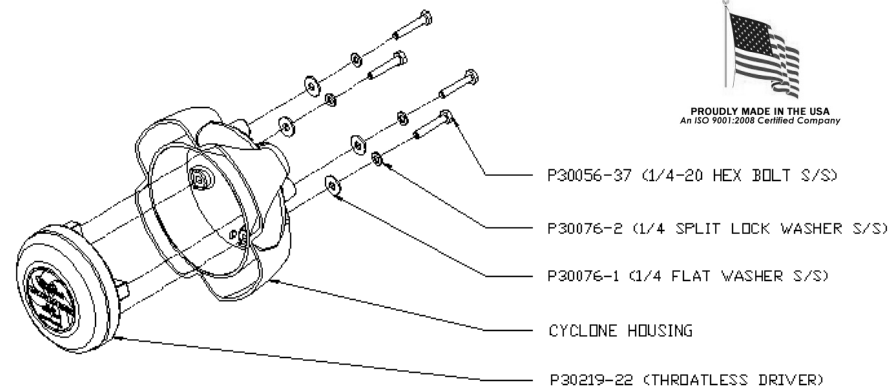

WARNING: ALWAYS WEAR HEARING PROTECTION PER OSHA 1910.95

Star Headlight & Lantern Co., Inc.
 455 Rochester Street Avon, NY 14414 Phone: 585-226-9787 FAX: 888-478-2797
 SINCE 1889 STAR WARNING SYSTEMS STARSIGNAL VEHICLE PRODUCTS BRADFORD Vehicle Solutions Inc. www.starheadlight.com

Star Headlight & Lantern Co., Inc.
 455 Rochester Street Avon, NY 14414 Phone: 585-226-9787 FAX: 888-478-2797
 SINCE 1889 STAR WARNING SYSTEMS STARSIGNAL VEHICLE PRODUCTS BRADFORD Vehicle Solutions Inc. www.starheadlight.com

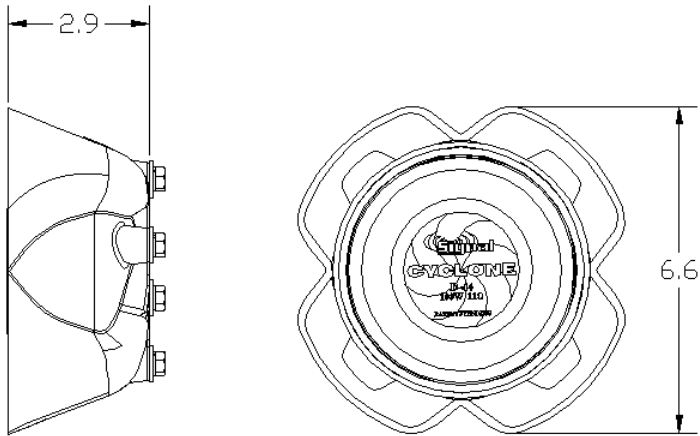

| MODEL # | DESCRIPTION/APPLICATION | BRACKET PART # |
|---------------|---|--------------------------|
| D-44 | SPEAKER ONLY | NO BRACKET |
| SPBRK-16 | UNIVERSAL "L" BRACKET 2004-2005 DODGE DURANGO 2001 FORD TAURUS 2002-2009 FORD EXPLORER 2004-2009 GMC ENVOY 2002-2009 CHEVROLET AVALANCHE 2004-2006 CHEVROLET SUBURBAN / TAHOE | P30150-237P |
| SPBRK-17 | 2003-2009 FORD CROWN VICTORIA (CENTER MOUNT) | P30150-238P |
| SPBRK-18 | 2007-2009 CHEVROLET SUBURBAN / TAHOE | P30150-239P |
| SPBRK-19 | 2006-2009 CHEVROLET IMPALA | P30150-240P |
| SPBRK-20 | 2006-2009 DODGE CHARGER 2005-2008 DODGE MAGNUM | P30150-241P |
| SPBRK-21 | TWO PIECE ADJUSTABLE BRACKET | S30150-218, P30150-218AP |
| SPBRK-22(L/R) | 2008-2009 FORD F250 & F350 | S30150-260(R/L) |
| SPBRK-23 | 2008-2009 FORD F350 & F450 | P30150-261P |
| SPBRK-24 | 2007-2012 FORD EXPEDITION | P30150-291P |
| SPBRK-27 | 2011-2012 DODGE CHARGER | P30150-302P |
| SPBRK-28 | 2010-2012 FORD TAURUS | P30150-303P |
| SPBRK-29 | 2011-2012 FORD F350 | P30150-318P |
| SPBRK-30 | 2011-2012 DODGE 4500 | P30150-319P |
| SPBRK-31 | 2011-2012 CHEVY CAPRICE | P30150-324P |

IMPORTANT!

Speaker must be mounted with drain hole/wiring exit facing down.

Failure to do so will void warranty!

Please Note: These instructions are provided as a general guideline only. Specific mounting, wiring, and/or weather-sealing may be necessary and are the sole responsibility of the installer. The manufacturer assumes no responsibility for the integrity of the installation for this or any of its products.

Optional Speaker Bracket Kits

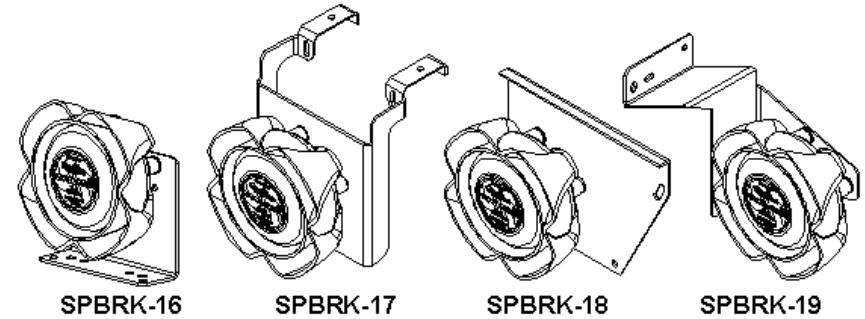

SPBRK-16

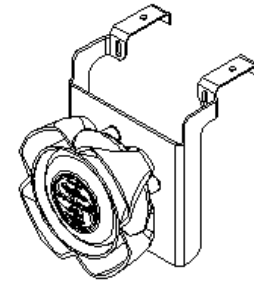

SPBRK-17

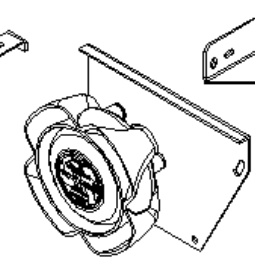

SPBRK-18

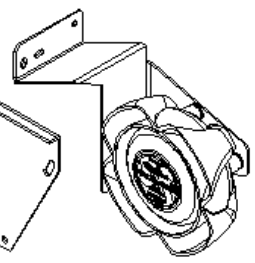

SPBRK-19

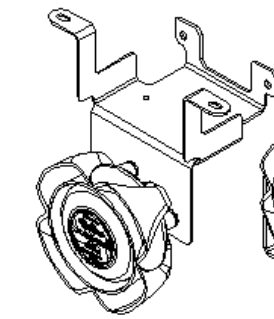

SPBRK-20

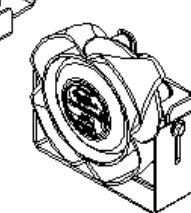

SPBRK-21

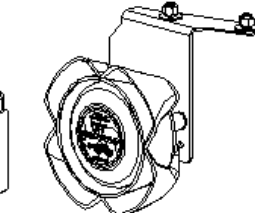

SPBRK-22(L/R)

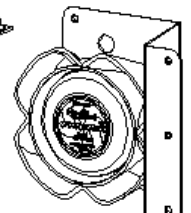

SPBRK-23

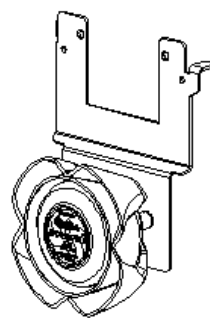

SPBRK-24

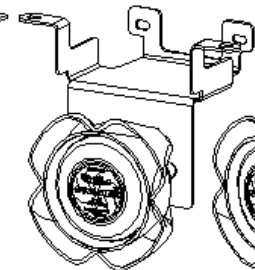

SPBRK-27



SPBRK-28

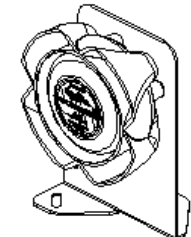

SPBRK-29

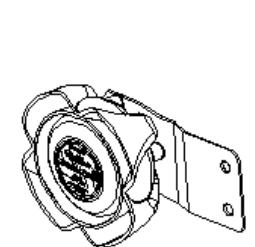

SPBRK-30

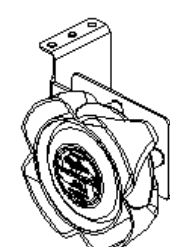

SPBRK-31